

EA-PSI 9000 2U 1000 W - 3000 W

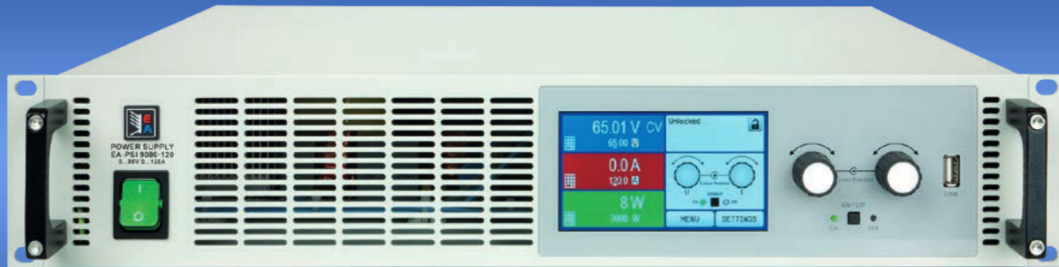

Programmable laboratory DC Power supplies



EA-PSI 9080-120 2U



- For wide range 90...264 V AC supply
- High efficiency up to 93%
- Output power ratings: 0...1000 W up to 0...3000 W
- Output voltages: 0...40 V up to 0...750 V
- Output currents: 0...4 A up to 0...120 A
- Flexible, power regulated output stage
- Various protection circuits (OVP, OCP, OPP, OTP)
- Intuitive TFT touch panel with display for values, status and notifications
- Remote sensing
- Galvanically isolated analog interface and USB port
- Integrated function generator
- Photovoltaics array simulation according to EN 50530
- Internal resistance simulation and regulation
- 40 V models compliant to SELV (EN 60950)
- Discharge circuit ($U_{out} < 60 \text{ V}$ in $\leq 10 \text{ s}$)
- Optional, digital interface modules or alternatively installed GPIB port
- SCPI command set and ModBus RTU (optionally: ModBus TCP) support
- LabView VIs and control software for Windows

General

The microprocessor-controlled laboratory power supplies of series EA-PSI 9000 2U offer a user-friendly, interactive handling concept, along with a remarkable set of standard features, which can facilitate operating them. Configuration of output parameters, supervision features and other settings, as well as the replaceable digital interface modules is smart and comfortable. The implemented supervision features for all output parameters can help to reduce test equipment and make it almost unnecessary to install external supervision hardware and software.

The clear control panel with its two knobs, one pushbutton, two LEDs and the touch panel with color TFT display for all important values and status enable the user to handle the device easily with a few touches of a finger.

For the integration into semi-automatic and remotely controlled test and automation systems, the devices offer a set of interfaces (analog and digital) on their rear side.

EA-PSI 9000 2U 1000 W - 3000 W

Autoranging power stage

All models are equipped with a flexible autoranging output stage which provides a higher output voltage at lower output current, or a higher output current at lower output voltage, always limited to the adjustable power set value or the rated power. Therefore, a wide range of applications can already be covered by the use of just one unit.

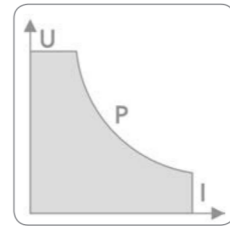

AC supply

All units are provided with an active **Power Factor Correction** circuit and models up to 1.5 kW are suitable for a worldwide usage on a mains supply from 90 V_{AC} up to 264 V_{AC}. With the 1.5 kW models, the output power is automatically reduced to 1 kW when the supply voltage is <150 V_{AC} and with the 3 kW models it's reduced to 2.5 kW at <205 V_{AC}.

DC output

DC output voltages between 0...40 V and 0...750 V, output currents between 0...4 A and 0...120 A and output powers between 0...1000 W and 0...3000 W are available. Current, voltage and power can thus be adjusted continuously between 0% and 100%, no matter if manually or remotely controlled (analog or digital). The output terminal is located on the rear panel of the devices.

Discharge circuit

Models with a nominal output voltage of 200 V or higher include a discharge circuit for the output capacities. For no load or low load situations, it ensures that the dangerous output voltage can sink to under 60 V DC after the DC output has been switched off. This value is considered as limit for voltages dangerous to human safety.

Built-in analog interface

There is a galvanically isolated analog interface terminal, located on the rear of the device. It offers analog inputs to set voltage, current, power and resistance from 0...100% through control voltages of 0 V...10 V or 0 V...5 V. To monitor the output voltage and current, there are analog outputs with 0 V...10 V or 0 V...5 V. Also, several inputs and outputs are available for controlling and monitoring the device status.

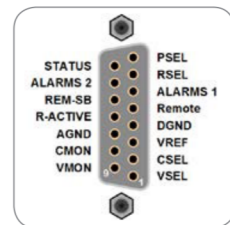

Protective features

For protection of the equipment connected, it is possible to set an overvoltage protection threshold (OVP), as well as one for overcurrent (OCP) and overpower (OPP). As soon as one of these thresholds is reached for any reason, the DC output will be immediately shut off and a status signal will be generated on the display and via the interfaces. There is furthermore an overtemperature protection, which will shut off the DC output if the device overheats.

Remote sensing

The standard sensing input can be connected directly to the load in order to compensate for voltage drops along the power cables, up to a certain level. Once the sensing input is connected to the load, the power supply will adjust the output voltage automatically to ensure the accurate required voltage is available at the load.

Display and control panel

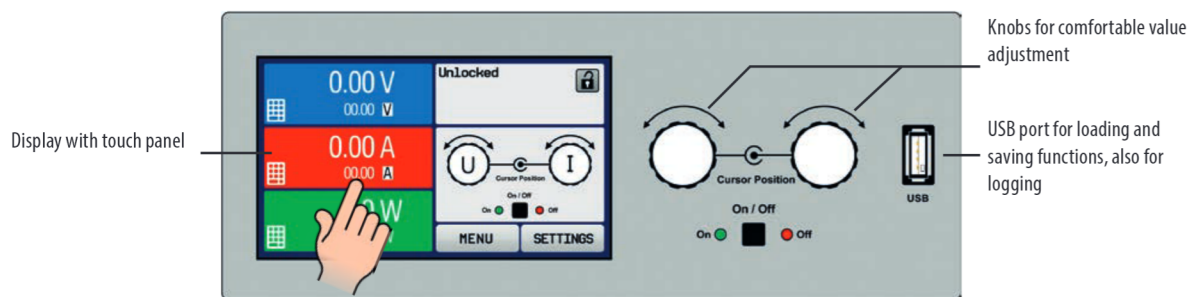

Set values and actual values of output voltage, output current and output power are clearly represented on the graphic display. The color TFT screen is touch sensitive and can be intuitively used to control all functions of the device with just a finger tip.

Set values of voltage, current, power or resistance (internal resistance simulation) can be adjusted using the rotary knobs or entered directly via a numeric pad. To prevent unintentional operations, all operation controls can be locked.

EA-PSI 9000 2U 1000 W - 3000 W



Multi-language screen

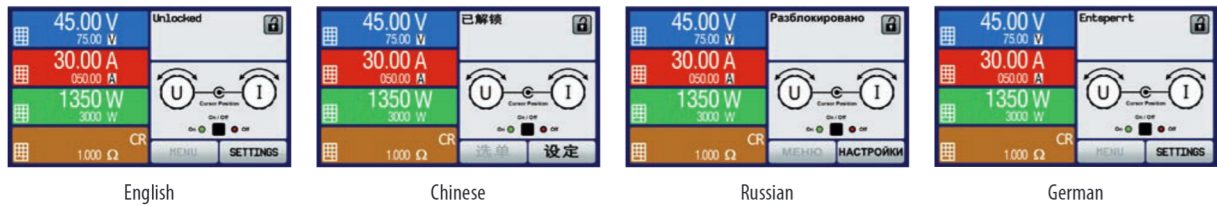

Function generator

All models of this series include a true function generator which can generate typical functions, as displayed in the figure below, and apply them to either the output voltage or the output current. The generator can be completely configured and controlled by using the touch panel on the front of the device, or by remote control via one of the digital interfaces.

The predefined functions offer all necessary parameters to the user, such as Y offset, time / frequency or amplitude, for full configuration ability.

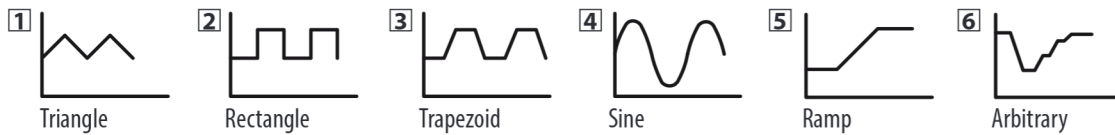

Additionally to the standard functions, which are all based upon a so-called arbitrary generator, this base generator is accessible for the creation and execution of complex sets of functions, separated into up to 99 sequences. Those can be used for testing purposes in development and production. The sequences can be loaded from and saved to a standard USB stick via the USB port on the front panel, making it easy to change between different test sequences.

There is furthermore an XY generator, which is used to generate other functions, such as UI or IU, which are defined by the user in form of tables (CSV file) and then loaded from USB drive. For photovoltaics related tests, a PV curve can be generated and used from user-adjustable key parameters. It also supports the european standard EN 50530.

Master-slave

All models feature a digital master-slave bus by default. It can be used to connect up to 32 units of identical models in parallel operation to a bigger system with totals formation of the actual value of voltage, current and power. The configuration of the master-slave system is either completely done on the control panels of the units or by remote control via any of digital communication interfaces. Handling of the master unit is possibly by manual or remote control (any interface).

Control software

Included with the device is a control software for Windows PC, which allows for the remote control of multiple identical or even different types of devices. It has a clear interface for all set and actual values, a direct input mode for SCPI and ModBus RTU commands, a firmware update feature and the semi-automatic table control named "Sequencing". Also see page 118.

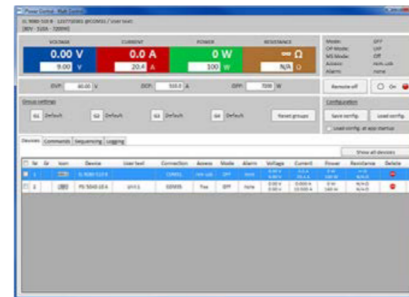
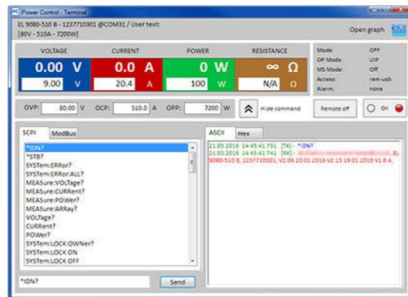

Options

- Isolated digital interface modules for RS232, CAN, CANopen, ModBus TCP, Profibus, Profinet/IO, EtherCAT or Ethernet. The interface slot is located on the rear panel (standard models only), making it easy for the user to plug in a new interface or to replace an existing one. The interface will be automatically detected by the device and requires no or only little configuration. Also see page 116.
- Three-way interface (3W) with a rigid GPIB port installed instead of the default slot for retrofittable interface modules

EA-PSI 9000 2U 1000 W - 3000 W

Digital interface modules



Autoranging principle

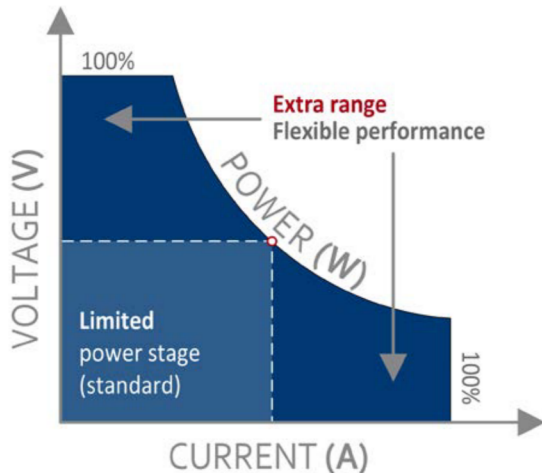

Model	Voltage	Current	Power	Efficiency	Ripple U ⁽²⁾	Ripple I ⁽²⁾	U (typ.)	I (typ.)	Ordering number ⁽³⁾
PSI 9040-40 2U	0...40 V	0...40 A	0...1000 W	≤92%	114 mV _{pp} / 8 mV _{RMS}	3.7 mA _{RMS}	~1.5 mV	~1.5 mA	06230319
PSI 9080-40 2U	0...80 V	0...40 A	0...1000 W	≤92%	114 mV _{pp} / 8 mV _{RMS}	3.7 mA _{RMS}	~3 mV	~1.5 mA	06230304
PSI 9200-15 2U	0...200 V	0...15 A	0...1000 W	≤93%	164 mV _{pp} / 34 mV _{RMS}	2.2 mA _{RMS}	~7.6 mV	~0.6 mA	06230305
PSI 9360-10 2U	0...360 V	0...10 A	0...1000 W	≤93%	210 mV _{pp} / 59 mV _{RMS}	1.6 mA _{RMS}	~13.7 mV	~0.4 mA	06230306
PSI 9500-06 2U	0...500 V	0...6 A	0...1000 W	≤93%	190 mV _{pp} / 48 mV _{RMS}	0.5 mA _{RMS}	~19 mV	~0.23 mA	06230307
PSI 9750-04 2U	0...750 V	0...4 A	0...1000 W	≤93%	212 mV _{pp} / 60 mV _{RMS}	0.3 mA _{RMS}	~28.6 mV	~0.15 mA	06230308
PSI 9040-60 2U	0...40 V	0...60 A	0...1500 W	≤92%	114 mV _{pp} / 8 mV _{RMS}	5.6 mA _{RMS}	~1.5 mV	~2.3 mA	06230320
PSI 9080-60 2U	0...80 V	0...60 A	0...1500 W	≤92%	114 mV _{pp} / 8 mV _{RMS}	5.6 mA _{RMS}	~3 mV	~2.3 mA	06230309
PSI 9200-25 2U	0...200 V	0...25 A	0...1500 W	≤93%	164 mV _{pp} / 34 mV _{RMS}	3.3 mA _{RMS}	~7.6 mV	~1 mA	06230310
PSI 9360-15 2U	0...360 V	0...15 A	0...1500 W	≤93%	210 mV _{pp} / 59 mV _{RMS}	2.4 mA _{RMS}	~13.7 mV	~0.6 mA	06230311
PSI 9500-10 2U	0...500 V	0...10 A	0...1500 W	≤93%	190 mV _{pp} / 48 mV _{RMS}	0.7 mA _{RMS}	~19 mV	~0.4 mA	06230312
PSI 9750-06 2U	0...750 V	0...6 A	0...1500 W	≤93%	212 mV _{pp} / 60 mV _{RMS}	0.5 mA _{RMS}	~28.6 mV	~0.23 mA	06230313
PSI 9040-120 2U	0...40 V	0...120 A	0...3000 W	≤92%	114 mV _{pp} / 8 mV _{RMS}	11 mA _{RMS}	~3 mV	~4.6 mA	06230321
PSI 9080-120 2U	0...80 V	0...120 A	0...3000 W	≤92%	114 mV _{pp} / 8 mV _{RMS}	11 mA _{RMS}	~1.5 mV	~4.6 mA	06230314
PSI 9200-50 2U	0...200 V	0...50 A	0...3000 W	≤93%	164 mV _{pp} / 34 mV _{RMS}	6.5 mA _{RMS}	~7.6 mV	~1.9 mA	06230315
PSI 9360-30 2U	0...360 V	0...30 A	0...3000 W	≤93%	210 mV _{pp} / 59 mV _{RMS}	5 mA _{RMS}	~13.7 mV	~1.2 mA	06230316
PSI 9500-20 2U	0...500 V	0...20 A	0...3000 W	≤93%	190 mV _{pp} / 48 mV _{RMS}	1.5 mA _{RMS}	~19 mV	~0.8 mA	06230317
PSI 9750-12 2U	0...750 V	0...12 A	0...3000 W	≤93%	212 mV _{pp} / 60 mV _{RMS}	0.9 mA _{RMS}	~28.6 mV	~0.5 mA	06230318

(1) Programmable resolution disregarding device errors

(2) RMS value: measured at LF with BWL 300 kHz, PP value: measured at HF with BWL 20 MHz

(3) Ordering number of the standard version, models with option(s) installed have different ordering numbers

EA-PSI 9000 2U 1000 W - 3000 W



Technical Data	Series PSI 9000 2U	
AC: Supply		
- Voltage	90...264 V, 1ph+N or 2ph (1000 W - 1500 W models) 180...264 V, 1ph+N or 2ph (3000 W models)	
- Frequency	45...66 Hz	
- Power factor	>0.99	
- Derating	1500 W models: < 150 V AC to P _{out max} 1000 W 3000 W models: < 207 V AC to P _{out max} 2500 W	
DC: Voltage		
- Accuracy	<0.1% of rated value	
- Load regulation 0-100%	<0.05% of rated value	
- Line regulation ±10% ΔU _{AC}	<0.02% of rated value	
- Regulation 10-100% load	<2 ms	
- Rise time 10-90%	Max. 30 ms	
- Overvoltage protection	Adjustable, 0...110% U _{Nom}	
DC: Current		
- Accuracy	<0.2% of rated value	
- Load regulation 1-100% ΔU _{DC}	<0.15% of rated value	
DC: Power		
- Accuracy	<1% of rated value	
Overvoltage category	2	
Protection	OTP, OVP, OCP, OPP, PF ⁽¹⁾	
Insulation		
- AC input to enclosure	2500 V DC	
- AC input to DC output	2500 V DC	
- DC output to enclosure (PE)	Negative: max. 400 V DC / positive: max. 400 V DC + output voltage	
Degree of pollution	2	
Protection class	1	
Display / control panel	Graphics display with touch panel	
Digital interfaces		
- Built-in	1x USB type B for communication, 1x GPIB (optional with option 3W)	
- Slot	1x for retrofittable plug-in modules (standard models only)	
Analog interface	Built in, 15 pole D-Sub (female), galvanically isolated	
- Signal range	0...5 V or 0...10 V (switchable)	
- Inputs	U, I, P, R, remote control on-off, DC output on-off, resistance mode on-off	
- Outputs	U, I, alarms, reference voltage, status	
- Accuracy U / I / P / R	0...10V: <0.2%	0...5 V: <0.4%
Parallel operation	Yes, with true master-slave, up to 32 units (via Share bus)	
Standards	EN 60950, EN 61326, EN 55022 Class B	
Cooling	Temperature-controlled fans	
Operation temperature	0...50 °C	
Storage temperature	-20...70 °C	
Humidity	<80%, non-condensing	
Operation altitude	<2000 m (1.242 mi)	
Mechanics	1000 W / 1500 W	3000 W
- Weight ⁽²⁾	12 kg (25.6 lb)	15 kg (33.1 lb)
- Dimensions (W x H x D) ⁽³⁾	19" x 2U x 463 mm (18.2")	19" x 2U x 463 mm (18.2")

⁽¹⁾ See page 126

⁽²⁾ Standard version, models with options may vary

⁽³⁾ Enclosure of the standard version and not overall size, versions with options may vary

EA-PSI 9000 2U 1000 W - 3000 W

Product views

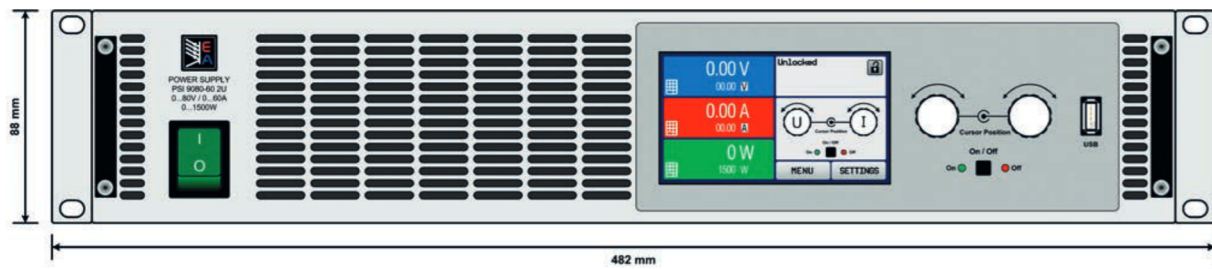

Front view

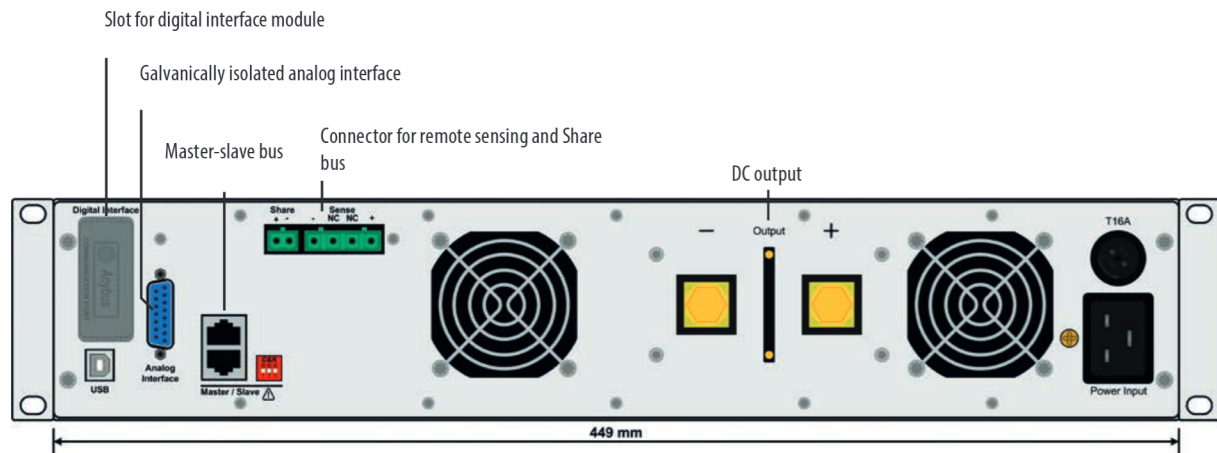

Rear view of base model

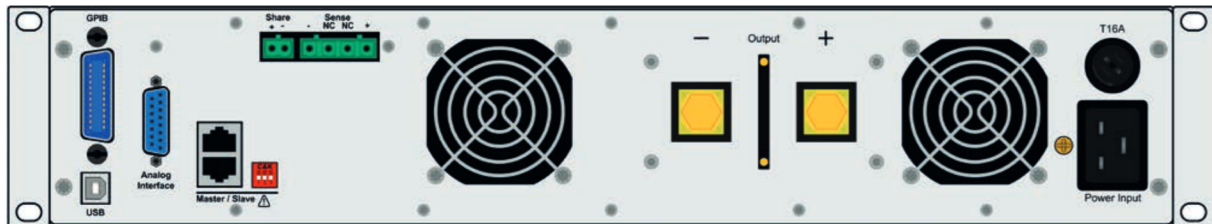

Rear view with option 3W

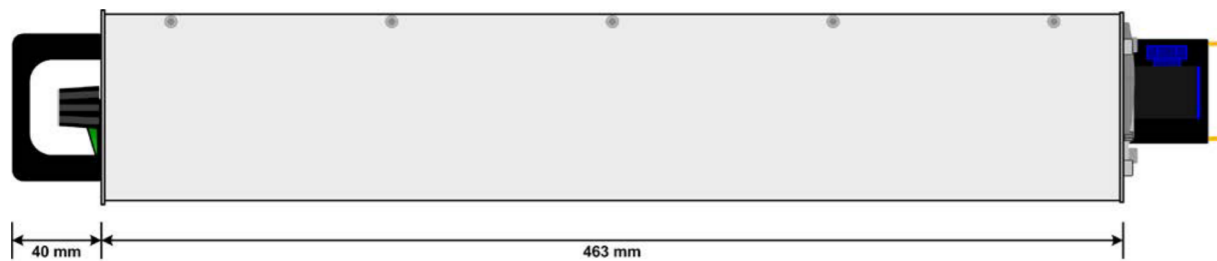

Side view of base model

